

Central Base with  
4 x 5mm / 3/16"  
fixation holes and  
2 x 22mm / 0.9"  
holes  
for electric cables

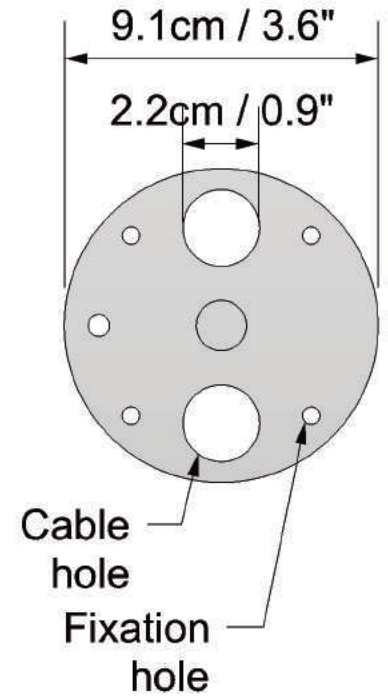

Sockets E26 or E27  
Voltage 120V or 220V  
Bulb 40W (100W max.)

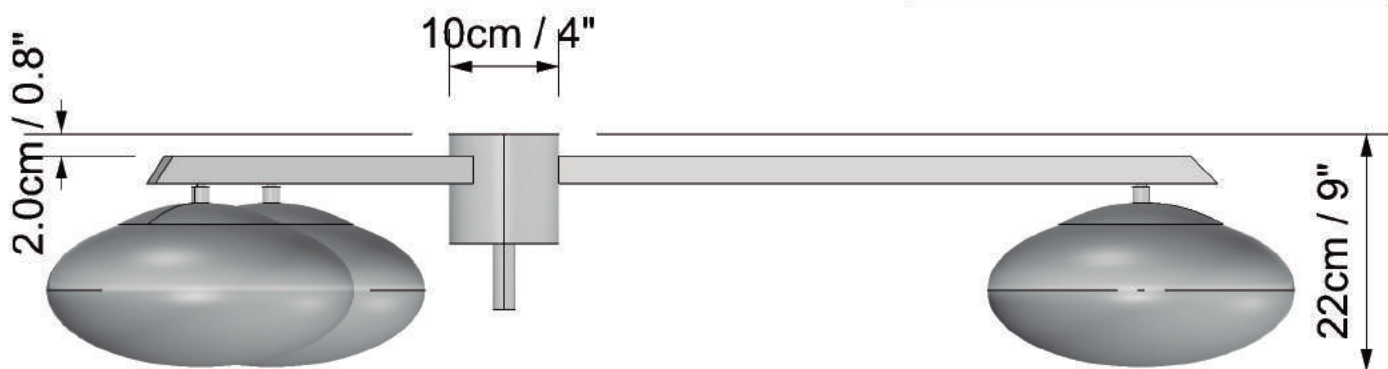

Its Thyme